

Amarillo Series Fan Drive

Model 110

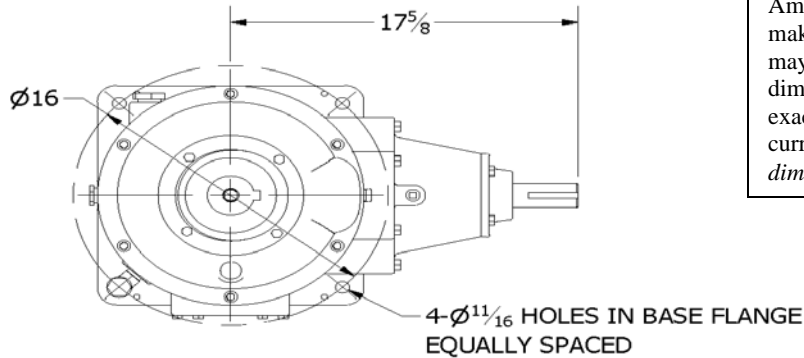

Amarillo Gear Company LLC reserves the right to make design modifications to our gear drives that may change the given dimensions. The dimensions shown in this document may not exactly reflect the dimensions of gear drives currently being offered. Request a *certified dimension print* for construction use.

HORIZONTAL KEYWAY: 3/8 x 3/16
VERTICAL KEYWAY: 5/8 x 5/16
NORMAL ROTATION: BOTH SHAFTS CLOCKWISE

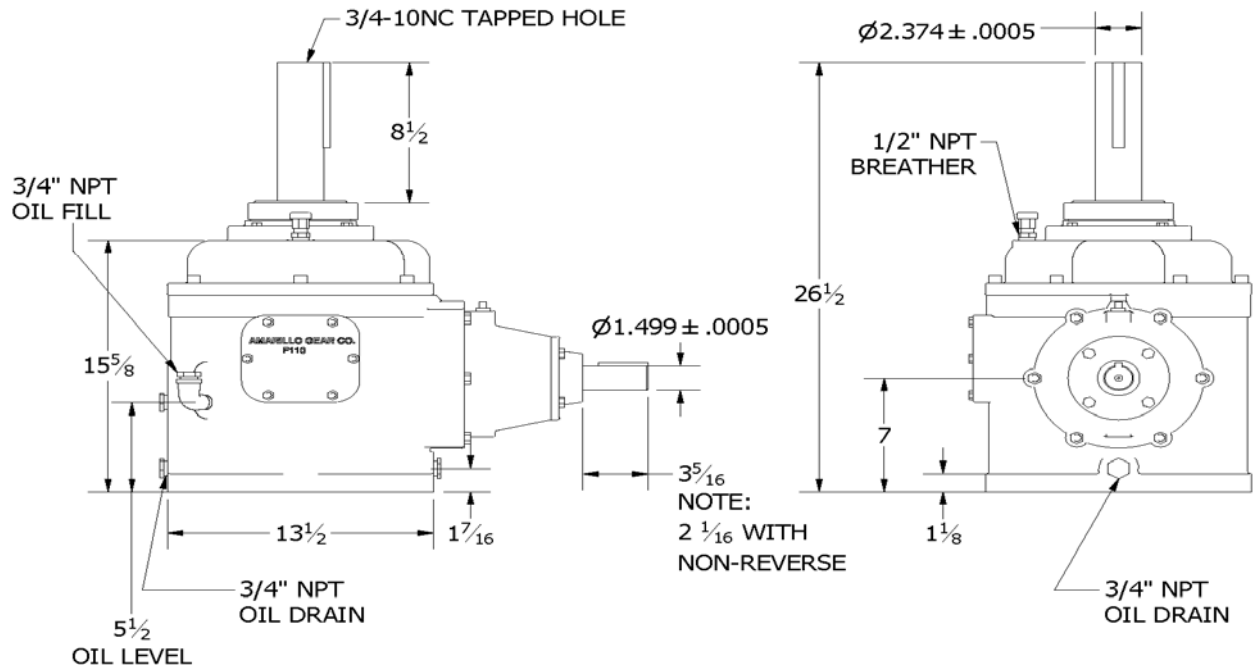

SERVICE HORSEPOWER RATINGS

(2.0 SERVICE FACTOR)

Input (RPM)	Nominal Ratio												
	3.5	3.75	4.0	4.25	4.5	4.75	5.0	5.5	6.0	6.5	7.0	7.5	8.0
1750	75	74	72	71	69	64	60	46	40	33	30	25	24
1450	62	61	60	59	57	53	50	38	33	27	25	21	20
1160	50	49	48	47	46	42	40	30	27	22	20	17	16

THRUST CAPACITY: _____ 2650 lbs.
 OIL TYPE: _____ ISO 220 / AGMA 5 or 5S / No EP additives
 OIL CAPACITY: _____ 2 gallons (8 L)
 WEIGHT, DOMESTIC SHIPPING: _____ 350 lbs.
 WEIGHT, EXPORT SHIPPING w/EXPORT BOX: _____ 395 lbs.
 EXPORT BOX DIMENSIONS (L x W x H): _____ 29 x 19 x 34 (inches)